

PART	LL PENCIL	LIST PRICE	
		Order (Missing)	Exchange (Damaged)
			
770-721 (GEP)	61	1.00	1.00
653-721-1 (Chrome Plated)	61	.75	.75
			
600-721 (14K Gold)	"51"	7.00	7.00
583-721 (GEP)	"51"	1.00	1.00
596-721 (Chrome Plated)	"51" and 41	.75	.75
			
713-721-1 (Chrome Plated)	Super "21"	.50	.50
			
573-721 (Chrome Plated)	"21" Special	.50	.50

60 - MISCELLANEOUS PENCIL PARTS

PART	LL PENCIL	LIST PRICE	
		Order (Missing)	Exchange (Damaged)

Desk Pencil Tapers

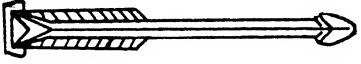
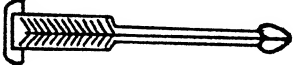
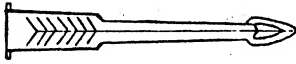
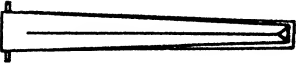
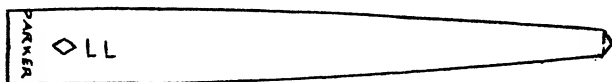

674-896	Desk Pencil (Not Drilled For Chain)	.60	.60
---------	--	-----	-----

686-896	Desk Pencil (Drilled For Chain)	.60	.60
---------	------------------------------------	-----	-----

Black, Charcoal

Cap Liners

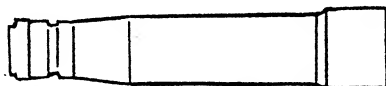

663-740	61	.30	.30
(Assembly)			

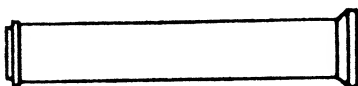

586-740	"51" Presidential, Insignia, and Flighter	.30	.30
---------	--	-----	-----

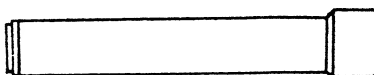

433-740-B	"51"	.30	.30
-----------	------	-----	-----

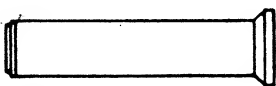

650-740	Demi "51" Presidential and Insignia	.30	.30
---------	--	-----	-----

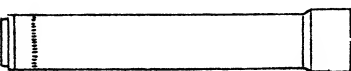

566-740-B	Demi "51"	.30	.30
-----------	-----------	-----	-----

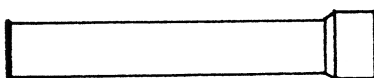

609-740	Super "21" and "21"	.30	.30
---------	---------------------	-----	-----

PART	LL PENCIL	LIST PRICE	
		Order (Missing)	Exchange (Damaged)

Cap Assembly Bushing

653-938	61	.15	.15
433-938	"51", 41, Super "21", and "21"	.15	.15

Clipscrew Bushing

653-897	61	.10	.10
400-897	"51" and 41	.10	.10

Clipscrew

653-811-1	61	.10	.10
400-811 (Black or Grey)	"51" and 41	.10	.10



609-811 (Chrome Plated)	Super "21" and "21"	.15	.15
----------------------------	---------------------	-----	-----

62 - JOTTER BARRELS

PART	JOTTER	LIST PRICE	
		Order (Missing)	Exchange (Damaged)



772-298 (14K Gold)	International Presidential	45.00	30.00
-----------------------	----------------------------	-------	-------

770-298 (Lustraloy)	International Flighter	3.50	3.50
------------------------	------------------------	------	------

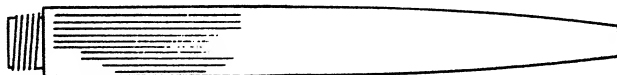

790-298 (1/10 14K Gold)	International Insignia	6.00	4.30
----------------------------	------------------------	------	------

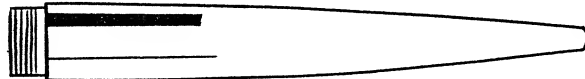

737-298 (14K Gold)	Minim	12.50	10.00
-----------------------	-------	-------	-------



733-298 (1/10 12K Gold)	Minim	4.50	3.00
----------------------------	-------	------	------

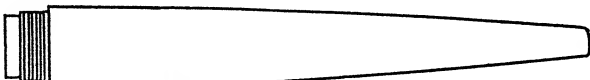



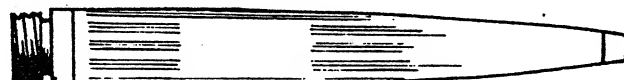

731-004	Minim	.60	.60
---------	-------	-----	-----



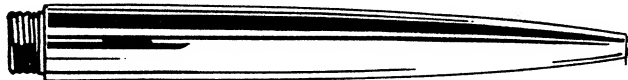
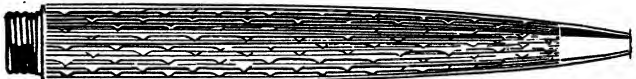

Black, Grey, Deep Blue, Red

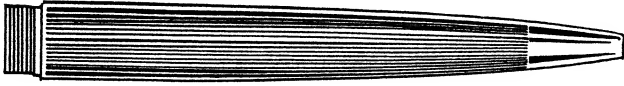

712-279 (1/10 12K Gold)	Insignia and V.I.P.	7.00	5.00
----------------------------	---------------------	------	------

PART	JOTTER	LIST PRICE	
		Order (Missing)	Exchange (Damaged)
			
755-338	V.I.P.	1.00	1.00
Black, Charcoal, Grey, Deep Blue, Red, Green			
			
624-279	"51" Custom	1.50	1.50
623-279	"51" Deluxe and Standard	1.50	1.50
Black, Navy Grey, Burgundy, Teal Blue			
			
748-338	Princess	1.50	1.50
Black, White			
			
752-298	Princess	3.75	2.75
Black			
750-298	Princess	3.75	2.75
Blue, Beige, Turquoise, Pink			
			
751-298 (GEP)	Princess	5.00	3.50
747-298 (GEP)	Princess	3.00	3.00

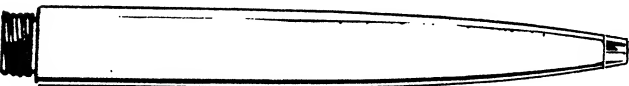
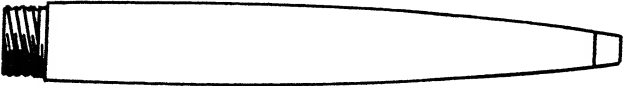
64 - JOTTER BARRELS





PART	JOTTER	LIST PRICE	
		Order (Missing)	Exchange (Damaged)
			
806-298 (GEP)	Imperial	1.90	1.90
			
734-298 (Lustraloy)	Custom (Cap Actuated) <i>H.S. Jotter</i>	1.50	1.50
			
705-338	Deluxe (Cap Actuated) Black, Grey, Charcoal, Blue, Green, Red	1.50 .75	1.50 .75
			
753-338	Debutante White, Blue, Beige, Pink, Turquoise	.60	.60
			
717-338	Special T-Ball and Pardner Black, Deep Blue, Charcoal, Green, Light Blue, Red	.65	.65
			
746-338	Jotter Desk. Pen Black	1.75	1.75

4



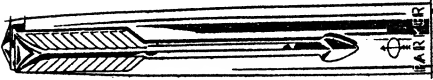

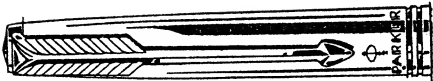
PART

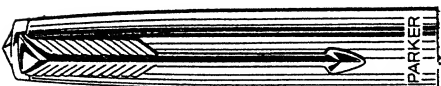
JOTTER

LIST PRICE
Order Exchange
(Missing) (Damaged)

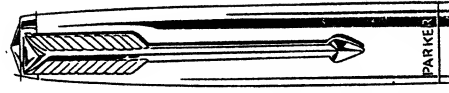
PART	JOTTER	LIST PRICE	
		Order (Missing)	Exchange (Damaged)
			
772-180	International Presidential	35.00	27.00
(Less Clip -- 772-002)		28.00	20.00
			
790-180	International Insignia	6.50	4.50
(Less Clip -- 790-002)		5.50	3.50
			
770-180	International Flighter	3.50	3.50
(Less Clip -- 770-109)		2.00	2.00
			
737-180	Minim	12.50	10.00
733-180	Minim	4.50	3.00
			
712-180	Insignia	7.00	5.00
(Less Clip -- 570-702)		6.00	4.00

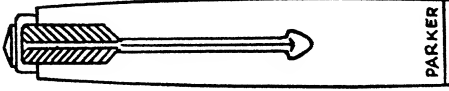
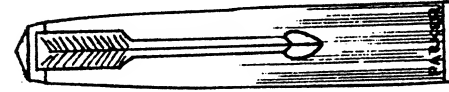
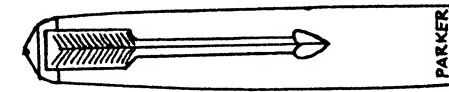
SEE PAGE TWO FOR CAP DESCRIPTIONS ...

PART	JOTTER	LIST PRICE	
		Order (Missing)	Exchange (Damaged)
 756-180 V.I.P. (Less Clip -- 570-702)		7.00	5.00
		6.00	4.00
 755-180 V.I.P. (Less Clip -- 755-002)		6.50	4.30
		5.00	3.30
 754-180 V.I.P. (Less Clip -- 754-002)		4.75	3.25
		4.00	2.75
 796-180 V.I.P. (Less Clip -- 754-002)		4.75	3.25
		4.00	2.75
 624-180 "51" Custom (Less Clip -- 587-702)		6.00	4.30
		5.00	3.30
 623-180 "51" Deluxe (Less Clip -- 586-702)		4.75	3.25
		4.00	2.75
 635-180 "51" Standard (Less Clip -- 635-702)		4.75	3.25
		4.00	2.75

68 - JOTTER CAPS

PART	JOTTER	LIST PRICE	
		Order (Missing)	Exchange (Damaged)



748-180	Princess	5.00	3.50
Black, White			



752-180	Princess	4.00	2.75
Black			

750-180	Princess	4.00	2.75
Blue, Beige, Turquoise, Pink			



749-180	Princess	2.50	2.50
Black			

747-180	Princess	2.50	2.50
Blue, Beige, Turquoise, Pink			

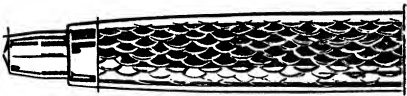

753-180	Debutante	2.25	2.25
White, Blue, Beige, Turquoise, Pink			

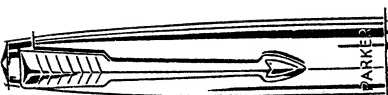

705-180 836-180	Custom and Deluxe (Cap Actuated)	1.50 1.25	1.50 1.25
-------------------------------	-------------------------------------	-------------------------	-------------------------

PART

JOTTER

LIST PRICE
 Order Exchange
 (Missing) (Damaged)

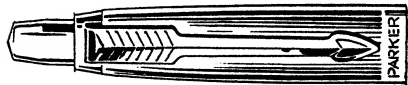

806-180 Imperial, GEP

2.15 2.15



780-180 Special and Pardner

1.50 1.50

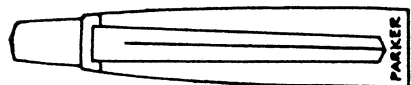

717-180 Special and Pardner
 Old Style

1.50 1.50

836-180 Custom Jotter
 45 J. Lighter
 45 Pardner

1.75 1.75

70 - JOTTER CLIPS

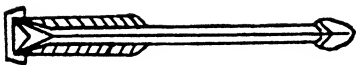
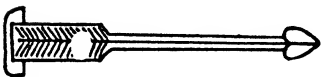
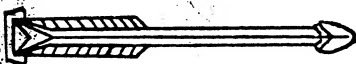
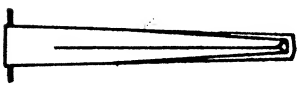
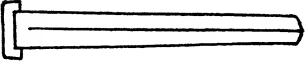
PART	JOTTER	LIST PRICE	
		Order (Missing)	Exchange (Damaged)
			
728-721 (14K Gold)	International Presidential	7.00	7.00
770-721 (GEP)	International Insignia and Flighter	1.00	1.00
			
600-721 (14K Gold)	"51"	7.00	7.00
583-721 (GEP)	"51"	1.00	1.00
596-721 (Chrome Plated)	"51"	.75	.75
			
653-013-1 (Chrome Plated)	V.I.P.	.75	.75
770-013 (GEP)	V.I.P.	1.00	1.00
			
917-632-013 (Chrome Plated)	"21" Special	.50	.50
			
671-013 (Chrome Plated)	Special T-Ball, Pardner, and Debutante	.50	.50

PART	JOTTER	LIST PRICE	
		Order (Missing)	Exchange (Damaged)

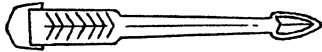

705-013 Custom and Deluxe
(Chrome Plated) (Cap Actuated)

.50

.50



780-013 New Special and Pardner
(Chrome Plated)

.50

.50

72 - MISCELLANEOUS JOTTER PARTS

PART	JOTTER	LIST PRICE	
		Order (Missing)	Exchange (Damaged)

Tapers For Desk Jotters

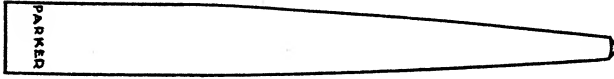

668-100	Desk Jotter	.60	.60
(Not Drilled For Chain)			

Black, Ivory, Charcoal, Red, Green, Deep Blue

685-100	Desk Jotter	.60	.60
(Drilled For Chain)			

Black, Ivory, Red, Green, Deep Blue



746-245	Jotter Desk Pen	4.40	1.40
---------	-----------------	------	------

Black

Parts For Caps -- Ratchet Frame Assemblies

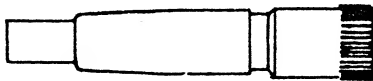

623-322	"51" and "21" Special	.40	.40
---------	-----------------------	-----	-----

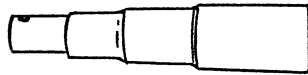

705-322	V.I.P.	.40	.40
---------	--------	-----	-----

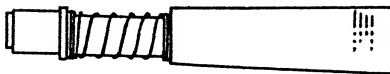

770-346	Internationals	.40	.40
---------	----------------	-----	-----

PART	JOTTER	LIST PRICE	
		Order (Missing)	Exchange (Damaged)

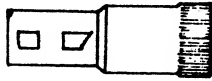
Parts For Caps -- Ratchet Frames

620-293-1	Button Actuated Jotters	.12	.12
-----------	-------------------------	-----	-----

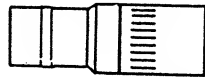

717-293	Pardner and Special	.15	.15
---------	---------------------	-----	-----

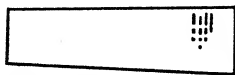

770-293	Internationals	.12	.12
---------	----------------	-----	-----

Parts For Caps -- Plunger Bushings

623-321	"51"	.10	.10
---------	------	-----	-----



632-321	"21" Special	.10	.10
---------	--------------	-----	-----



754-352	V.I.P.	.10	.10
---------	--------	-----	-----

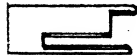

770-321	Internationals	.10	.10
---------	----------------	-----	-----

Parts For Caps -- Plungers

717-125	Pardner and Special	.10	.10
---------	---------------------	-----	-----

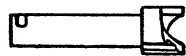

770-125	Internationals	.10	.10
---------	----------------	-----	-----

74 - MISCELLANEOUS JOTTER PARTS

PART	JOTTER	LIST PRICE	
		Order (Missing)	Exchange (Damaged)

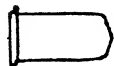
Parts For Caps -- Buttons

717-288	Pardner and Special	.12	.12
---------	---------------------	-----	-----

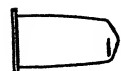

733-288 (GEP)	Minim	.50	.50
------------------	-------	-----	-----

737-288 (14K Gold)	Minim	3.50	3.50
-----------------------	-------	------	------

Parts For Caps -- Springs

717-289	Pardner and Special, Button Actuated Jotters	.05	.05
---------	---	-----	-----

770-289	Internationals	.05	.05
---------	----------------	-----	-----



731-055 (Toggle Spring)	Minim	.05	.05
----------------------------	-------	-----	-----









Cap Liner

731-344	Minim	.30	.30
---------	-------	-----	-----

Outer Caps

733-002 (1/10 12K Gold Filled)	Minim	3.75	3.00
-----------------------------------	-------	------	------

737-002 (14K Gold)	Minim	8.75	6.00
-----------------------	-------	------	------

PART	JOTTER	LIST PRICE	
		Order (Missing)	Exchange (Damaged)
<u>Clipscrews</u>			
			
400-811	"51"	.10	.10
			
770-811 (Black Only)	International Flighter and Insignia	.10	.10
			
609-811	"21" Special	.15	.15
<u>Clipscrew Bushings</u>			
			
400-897	"51"	.10	.10
770-097	International Flighter and Insignia	.10	.10
<u>Barrel Connectors</u>			
			
623-052	"51"	.15	.15
			
712-052	V.I.P.	.15	.15
<u>Barrel Bands</u>			
			
669-096 (Chrome Plated)	Desk Pen	.10	.10
			
746-096 (GEP)	Jotter Desk Pen	.60	.60

76 - MISCELLANEOUS JOTTER PARTS

PART	JOTTER	LIST PRICE	
		Order (Missing)	Exchange (Damaged)

Retracting Spring





WWWWWWWWW

620-294-1	All Jotters	.05	.05
-----------	-------------	-----	-----

Tip Bushing

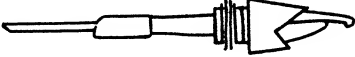
□

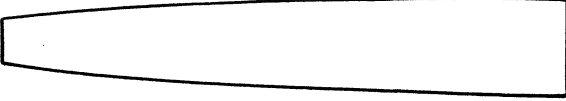
621-299	Custom, Internationals	.05	.05
---------	------------------------	-----	-----

PART	PEN	LIST PRICE	
		Order (Missing)	Exchange (Damaged)
			
760-270	Nib Assembly (Black only)	2.14	2.14
			
760-364	Collector Shell, Collector and Nipple Assembly	.60	.60
			
760-096	Barrel Band	.10	.10
			
760-004	Barrel <i>Super 2) Colais</i>	.40	.40
			
760-357	Reservoir Assembly	.95 95	.95 95
			
760-180	Cap w/clip	2.25	2.25
760-002	Cap 1/clip	1.35	1.35

78 - 45 PEN

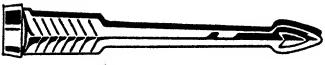
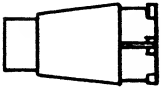
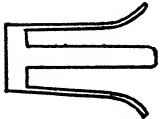
PART	PEN	LIST PRICE	
		Order (Missing)	Exchange (Damaged)
 760-111	Clip Screw	.15	.15
 760-013	Clip	.50	.50
 760-011	Inner Cap	.10	.10
 760-152	Clutch	.15	.15

PART	PEN	LIST PRICE	
		Order (Missing)	Exchange (Damaged)



760-270	Nib Assembly (for all 45 pens) (Black only)	2.14	2.14
---------	--	------	------



760-364	Collector Shell, Collector and Nipple Assembly (for all 45 pens) Same colors as plastic barrel	.60	.60
---------	--	-----	-----



760-096	Barrel Band, Chrome Plated (for Standard & Flighter)	.10	.10
---------	---	-----	-----

811-096	Barrel Band, GEP (for Custom & Insignia)	.15	.15
---------	---	-----	-----

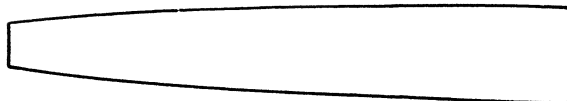

760-004	Barrel, Plastic (for Standard & Custom)	.40	.40
---------	--	-----	-----



Black, Red, Grey, Light Blue,
Dark Blue, Green



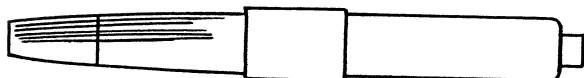

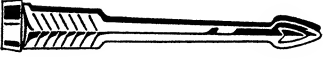
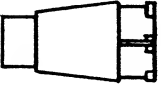
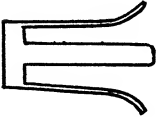

761-343	Barrel Assembly, Lustraloy with black plastic tip (for Flighter)	3.10	2.10
---------	---	------	------

812-343	Barrel Assembly, GEP with black plastic tip (for Insignia)	3.50	2.50
---------	---	------	------

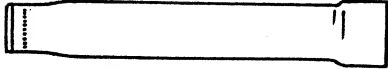
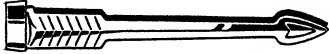

760-357	Converter	.95	.95
---------	-----------	-----	-----

PART	PEN	LIST PRICE	
		Order (Missing)	Exchange (Damaged)
			
760-180	Cap w/clip, Lustraloy	2.25	2.25
760-002	Cap 1/clip, Lustraloy (for Standard & Flighter)	1.35	1.35
			
811-180	Cap w/clip, GEP	5.40	3.75
811-002	Cap 1/clip, GEP (for Custom & Insignia)	4.10	2.45
			
760-111	Clip Screw, Chrome Plated (for Standard & Flighter)	.15	.15
811-111	Clip Screw, GEP (for Custom & Insignia)	.15	.15
			
760-013	Clip, Chrome Plated (for Standard & Flighter)	.50	.50
811-013	Clip, GEP (for Custom & Insignia)	1.00	1.00
			
760-011	Inner Cap (for all 45 caps)	.10	.10
			
760-152	Clutch (for all 45 caps)	.15	.15

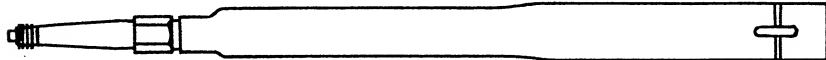
PART	PENCIL	LIST PRICE	
		Order (Missing)	Exchange (Damaged)
			
760-841	Cap w/clip, Lustraloy	1.75	1.75
760-702	Cap l/clip, Lustraloy (for Standard & Flighter)	1.00	1.00
			
811-841	Cap w/clip, GEP	3.85	2.90
811-702	Cap l/clip, GEP (for Custom & Insignia)	2.55	1.75
			
760-740	Cap Liner Assembly	.30	.30
			
760-721	Clip, Chrome Plated (for Standard & Flighter)	.50	.50
811-013	Clip, GEP (for Custom & Insignia)	1.00	1.00
			
760-111	Clip Screw, Chrome Plated (for Standard & Flighter)	.15	.15
811-111	Clip Screw, GEP (for Custom & Insignia)	.15	.15
			
666-704	Barrel, Plastic (for Standard and Custom) - Same colors as plastic 45 pen barrel	1.30	.70
770-840	Barrel, Lustraloy (for Flighter)	2.35	1.90
807-840	Barrel, GEP (for Insignia)	4.10	2.45
			
693-705	Point, Chrome Plated (for Standard)	.60	.60
779-705	Point, Chrome Plated (for Flighter)	.60	.60
746-705	Point, GEP (for Custom)	.60	.60
812-705	Point, GEP (for Insignia)	.60	.60
			
760-866	Mechanism	1.10	1.10

80 - EVERSHARP "10,000" PEN

PART #	PART	LIST PRICE
--------	------	------------

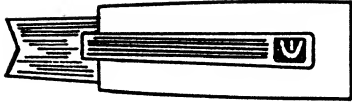

E11-005	Cap w/clip*	.70
---------	-------------	-----



E11-023	Nib & Shell Assy. * (Nib, Feed, Shell, Collector, Connector)	.98
---------	--	-----

Ex. Fine, Fine, Medium, Broad

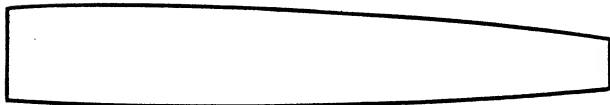

E11-016	Barrel *	.35
---------	----------	-----

Black, Red, Blue, Grey, Green, White

*Order by color

PART	EVERSHARP	* LIST PRICE	
		Order (Missing)	Exchange (Damaged)

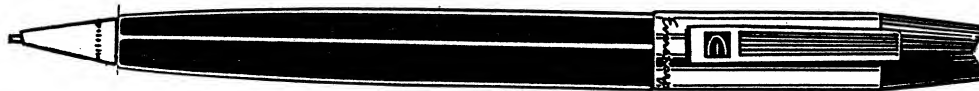

DELUXE MECHANICAL PENCIL (1801)

E1-841	*Cap w/clip (Chrome Plated)	.60	.60
E3-900	*Barrel & Mech. Assembly (Round)	.75	.75
E1-900	*Barrel & Mech. Assembly (Triangular)	.75	.75

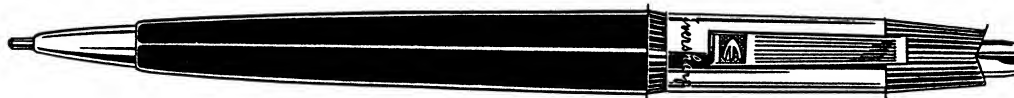

DELUXE FOUNTAIN BALL (807)

E1-180	*Cap w/clip (Chrome Plated)	.65	.65
E27-279	*Barrel Assembly (Round)	.35	.35
E12-279	*Barrel Assembly (Triangular)	.35	.35



FOUNTAIN BALL (801)

E1-180	*Cap w/clip (Chrome Plated)	.65	.65
E3-004	*Barrel (Round)	.10	.10
E1-004	*Barrel (Triangular)	.10	.10

*Colors: Black, Blue, Red, Grey, Green, White

PART	EVERSHARP	LIST PRICE	
		Order (Missing)	Exchange (Damaged)



BAGETTE (811)

E19-180	*Cap w/clip (Chrome Plated)	.70	.70
E28-004	*Barrel (Round)	.10	.10
E19-004	*Barrel (Triangular)	.10	.10

*Colors: Black, Blue, Red, Grey, Green, White



TEENA (814)

E20-180	*Cap w/clip (Gold Electroplated)	.85	.85
E28-004	*Barrel (Round)	.10	.10
E19-004	*Barrel (Triangular)	.10	.10

*Colors: Black, Blue, Red, Grey, Green, White

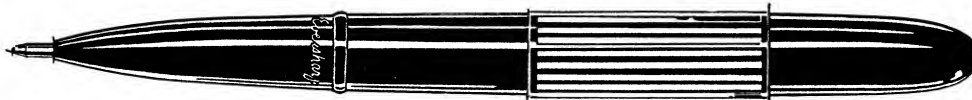

GAMIN (806)

E14-160	*Cap Assembly	1.35	1.35
E14-001	*Barrel	.10	.10
E14-004	*Nose Piece	.20	.20

*Colors: Black, Blue, Red, Grey, Green, White, Yellow

PART	EVERSHARP	* LIST PRICE	
		Order (Missing)	Exchange (Damaged)

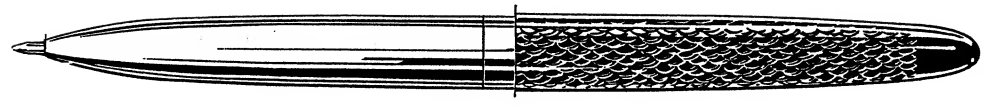

TIARA (804)

E13-003	*Cap Assembly	1.90	1.90
E13-298	Barrel (Gold Electroplated)	.45	.45
E13-343	Crown Assembly (Gold Electroplated)	.45	.45

*Colors: Black, Blue, Red, Green, White, Gold

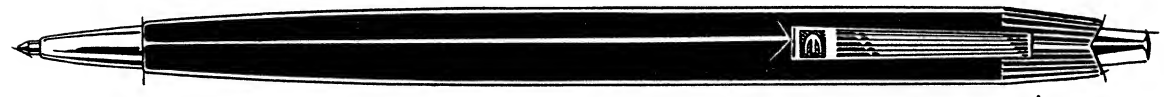

REPORTER (803)

E8-180	*Crown & Clip Assembly	.35	.35
E8-338	*Barrel & Point Assembly	.40	.40

*Colors: Black, Blue, Red, Grey, Green, White, Yellow

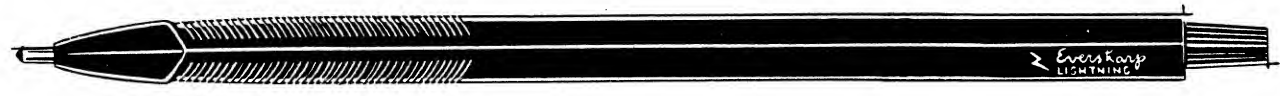

LIGHTNING - RETRACTABLE (812)

E6-115	*Barrel Crown	.10	.10
E6-004	*Barrel	.20	.20

*Transparent Colors: Gunsmoke, Burgundy, Blue, Green
 Opaque Colors: Red, Azure, White, Yellow, Aqua

PART	EVERSHARP	LIST PRICE	
		Order (Missing)	Exchange (Damaged)

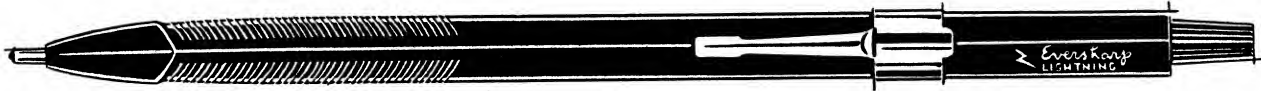

LIGHTNING - RETRACTABLE W/CLIP (822)

E6-115	*Barrel Crown	.10	.10
E6-004	*Barrel	.20	.20
E7-013	Clip	.12	.12

*Transparent Colors: Gunsmoke, Burgundy, Blue, Green
 Opaque Colors: Red, Azure, White, Yellow, Aqua

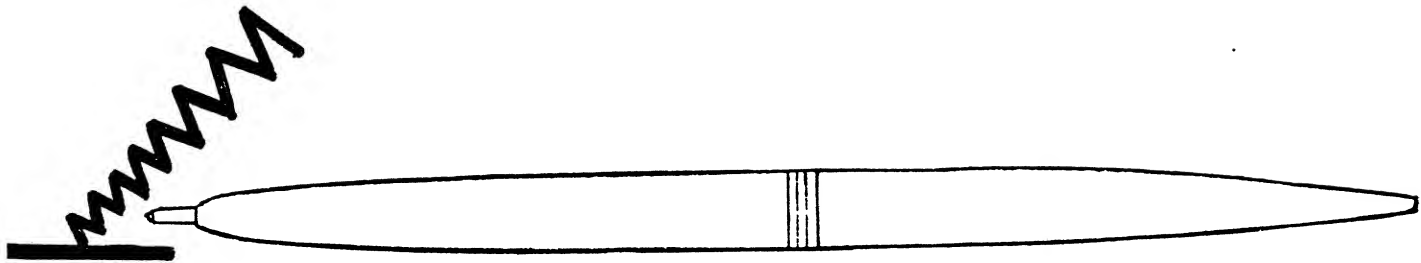

"CLIP-ON" DESK FOUNTAIN BALL (101)

E30-100	*Taper	.25	.25
E30-004	*Barrel	.25	.25
E30-096	Ring	.10	.10
E30-042	Clip-on Spring	.15	.15

*Colors: Black, Blue, Red, Ivory, Green

PART	JOTTER	* LIST PRICE	
		Order (Missing)	Exchange (Damaged)

61 Insignia Presentation
(Cap Actuated)



818-180	Cap w/clip	6.00	4.30
818-002	Cap 1/clip	5.00	3.30

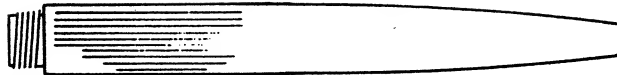

818-298	Barrel & Connector Assembly	6.00	4.30
---------	-----------------------------	------	------

770-721	Clip - see page 70		
770-811	Clipscrew - see page 75		
770-097	Clipscrew Bushing - see page 75		
770-321	Plunger Bushing - see page 73		
770-289	Plunger Spring - see page 74		
770-125	Plunger - see page 73		
770-293	Ratchet Frame - see page 73		
770-346	Ratchet Frame Assem. - see page 72		
621-299	Tip Bushing - see page 76		
620-294-1	Retracting Spring - see page 76		

61 Custom Presentation (V.I.P.)
(Cap Actuated)



799-180	Cap w/clip	6.50	4.50
799-002	Cap 1/clip	5.50	3.50

770-013	Clip - see page 70		
400-811	Clipscrew - see page 75		
400-897	Clipscrew Bushing - see page 75		
770-125	Plunger - see page 73		
770-289	Plunger Spring - see page 74		
734-293	Ratchet Frame Assem. - see page 73		
755-338	Barrel & Point Assem. - see page 63		
620-294-1	Retracting Spring - see page 76		

Colors: Black, Charcoal, Rage Red, Vista Blue, Surf Green

PART	JOTTER	LIST PRICE	
		Order (Missing)	Exchange (Damaged)

61 Classic Presentation
(Cap Actuated)

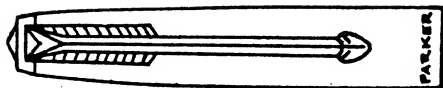

800-180	Cap w/clip	3.50	3.50
800-002	Cap l/clip	2.25	2.25
653-013-1	Clip -- see page 70		
400-811	Clipscrew - see page 75		
400-897	Clipscrew Bushing - see page 75		
770-125	Plunger - see page 73		
770-289	Plunger Spring - see page 74		
734-293	Ratchet Frame Assembly - see page 73		
705-338	Barrel & Point Assem. - see page 64		

Colors: Black, Charcoal, Rage Red, Vista Blue, Surf Green

International Insignia
(Cap Actuated)



807-180	Cap w/clip	5.00	3.30
807-002	Cap l/clip	4.00	2.75

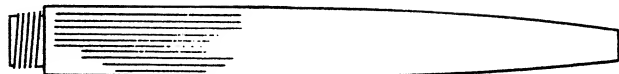

807-298	Barrel & Connector Assembly	4.50	3.00
770-721	Clip - see page 70		
770-811	Clipscrew - see page 75		
770-097	Clipscrew Bushing - see page 75		
770-321	Plunger Bushing - see page 73		
770-289	Plunger Spring - see page 74		
770-125	Plunger - see page 73		
770-293	Ratchet Frame - see page 73		
770-346	Bushing, spring, plunger & ratchet frame assem. - see page 72		
621-299	Tip Bushing - see page 76		
620-294-1	Retracting Spring - see page 76		

PART	JOTTER	* LIST PRICE	
		Order (Missing)	Exchange (Damaged)

White Imperial - Button Actuated
(Rhodium Plated)

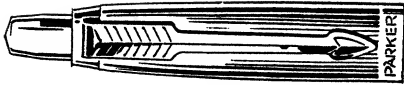

835-180	Cap, complete	2.15	2.15
---------	---------------	------	------



835-298	Barrel & Connector Assembly (Line Engraved)	1.90	1.90
---------	--	------	------

Golden Cap - Button Actuated



806-180 (GEP)	Cap, complete	2.15	2.15
------------------	---------------	------	------

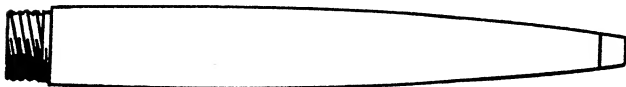

748-338	Barrel & Point Assembly	.85	.85
---------	-------------------------	-----	-----

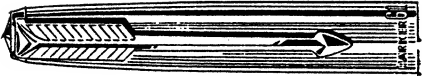
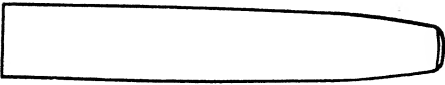

Colors: Black, Oxford Grey, Dark Blue,
Green, Dusty Blue, Red

PART	PENCIL	LIST PRICE	
		Order (Missing)	Exchange (Damaged)
61 Custom Presentation			
			
799-841	Cap w/clip	7.00	5.00
799-702	Cap 1/clip	6.00	4.30
			
754-704	Barrel	1.30	.70
754-740	Cap Liner Assembly	.30	.30
770-721	Clip - see page 48		
400-897	Clipscrew Bushing - see page 50		
400-811	Clipscrew - see page 50		
755-705	Point - see page 34		
Colors:	Black, Charcoal, Rage Red, Vista Blue, Surf Green		

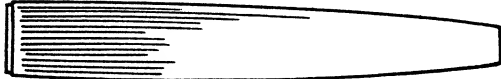

61 International Insignia

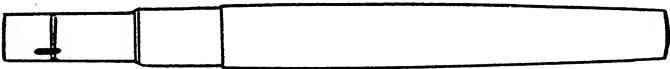

			
807-841	Cap Assembly	3.50	3.50
807-002	Cap 1/clip	2.50	2.50
			
807-840	Barrel & Liner Assembly	3.50	3.50
770-721	Clip - see page 48		
666-931	Movement & Magazine Assem. - see page 35		
728-705	Point - see page 33		

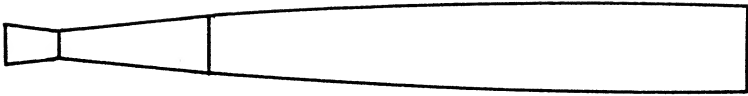
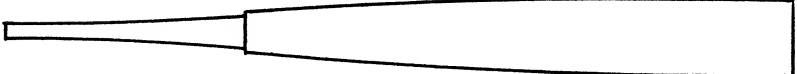
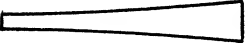
White Imperial (Rhodium Plated)

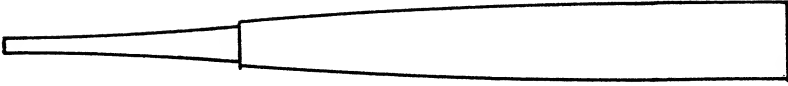
			
835-841	Cap w/clip	1.70	1.70
			
835-907	Barrel Assembly (Rhodium Plated, Line Engraved)	2.00	2.00
			
835-881	Mechanism	.95	.95

PART	PEN	LIST PRICE	
		Order (Missing)	Exchange (Damaged)
61 Desk Pen			
			
826-332	Barrel & Taper Assembly	4.00	2.60
45 Desk Pen			
			
827-285	Barrel & Taper Assembly	2.40	2.40
827-004	Barrel only	.40	.40
			
827-100	Taper only	1.95	1.95
827-173	Taper Screw	.05	.05
760-270	Nib Assembly - see page 77		
760-364	Collector Shell & Collector Assembly - see page 77		
760-096	Barrel Band - see page 77		

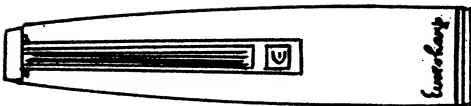
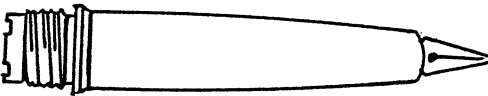
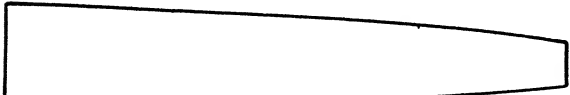
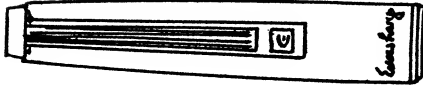
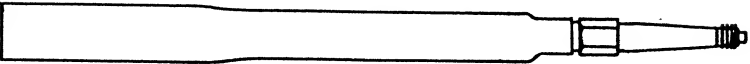
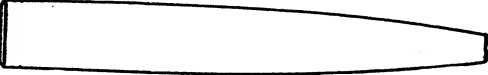
PART	PEN	LIST PRICE	
		Order (Missing)	Exchange (Damaged)
45 Ballpoint Desk Pen			
			
827-285	Barrel & Taper Assembly (less Spring)	2.40	2.40
804-055	Barrel Spring	.10	.10
827-004	Barrel only	.40	.40
827-100	Taper only	1.95	1.95
827-173	Taper Screw	.05	.05
			
804-278	Point, chrome plated	.50	.50
			
760-151	Shell	.25	.25
760-096	Barrel Band - see page 77		

PART	PEN	* LIST PRICE	
		Order (Missing)	Exchange (Damaged)
			
E32-180	Cap w/clip	1.30	1.30
			
E32-286	Nib & shell assembly (nib, feed, collector & shell)	1.40	1.40
			
809-004	Barrel	.40	.40
	PENCIL		
			
E32-841	Cap w/clip	.90	.90
			
809-937	Mechanism	.85	.85
			
E32-704	Barrel	.35	.35
			
693-705	Point	.60	.60

Colors: Black, Red, Grey, Deep Blue, Green, Light Blue

PART NUMBER

45 JOTTERS

LIST PRICE
Order Exchange
(Missing) (Damaged)

45 *Standard*

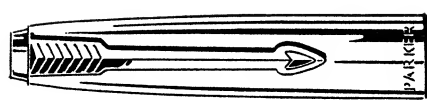

CAP

836-180	With Clip	\$1.75	\$1.75
836-002	Less Clip	.70	.70

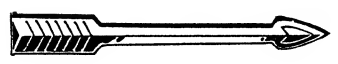

CLIP

836-013	Chrome Plated	.50	.50
---------	---------------	-----	-----



BARREL & POINT ASSEMBLY

705-338	Colors: Black, Blue, Red, Green, Oxford Grey, Dusty Blue	.75	.75
---------	--	-----	-----



RACHET FRAME ASSEMBLY

836-346		.40	.40
---------	--	-----	-----

760-111 Clip Screw -- see page 78

45 *Flighter*

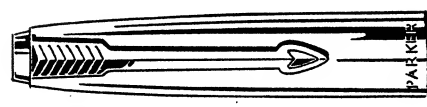

CAP

836-180	With Clip	1.75	1.75
836-002	Less Clip	.70	.70

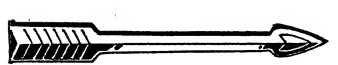

CLIP

836-013	Chrome Plated	.50	.50
---------	---------------	-----	-----

93 -- JOTTERS

PART NUMBER

45 JOTTERS

	LIST PRICE	
	Order	Exchange
	(Missing)	(Damaged)

45 *Flighter* (cont'd)

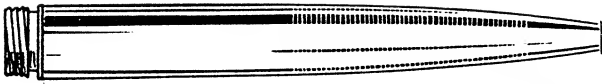

BARREL & CONNECTOR ASSEMBLY

734-298

\$1.50

\$1.50



RACHET FRAME ASSEMBLY

836-346

.40

.40

760-111

CLIP SCREW -- see page 78

45 *Custom*

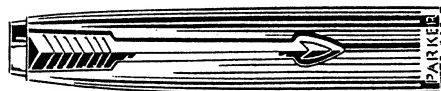

CAP

838-180

With Clip

3.50

2.50

838-002

Less Clip

1.95

1.65

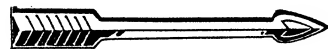

CLIP

838-013

G. E. P.

1.00

1.00



BARREL & POINT ASSEMBLY

755-338

Colors: Black, Blue, Red,
Green, Oxford Grey,
Dusty Blue

1.00

1.00

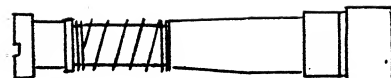

RACHET FRAME ASSEMBLY

836-346

.40

.40

811-111

CLIP SCREW -- see page 79

PART NUMBER

45 JOTTERS

LIST PRICE

Order
(Missing)

Exchange
(Damaged)

45 *Insignia*

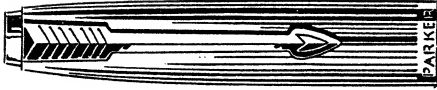

CAP

838-180

With Clip

\$3.50

\$2.50

838-002

Less Clip

1.95

1.65

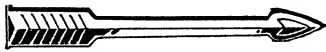

CLIP

838-013

1.00

1.00



BARREL & CONNECTOR ASSEMBLY

839-298

2.65

2.65



RACHET FRAME ASSEMBLY

836-346

.40

.40

811-111

CLIP SCREW -- see page 79

95 -- DESK PEN & PENCIL

PART NUMBER

"51" DESK PEN

LIST PRICE
Order Exchange
(Missing) (Damaged)

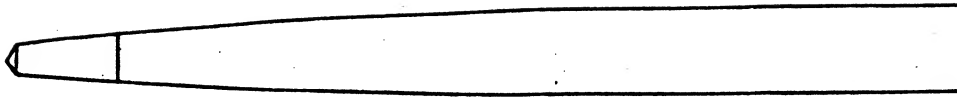

COMPLETE TAPER ASSEMBLY

842-285	Chrome Plated Tip	\$4.40	\$1.40
---------	-------------------	--------	--------



CLUTCH RING

342-148	Chrome Plated	.10	.10
---------	---------------	-----	-----

626-165	NIB -- See page 1
---------	-------------------

673-151	COLLECTOR SHELL -- See page 5
---------	-------------------------------

673-194	FILLER ASSEMBLY -- See page 14
---------	--------------------------------

596-149	COLLECTOR -- See page 3
---------	-------------------------

626-260	FEED -- See page 2
---------	--------------------

61 DESK PENCIL

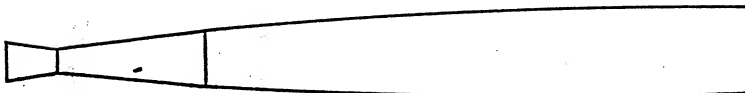

COMPLETE TAPER ASSEMBLY

826-901		6.00	2.60
---------	--	------	------

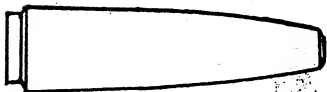

BARREL

826-704		2.25	1.00
---------	--	------	------



POINT

811-705		.60	.60
---------	--	-----	-----

809-937	MECHANISM -- See page 91
---------	--------------------------

659-096-1	BARREL BAND -- See page 6
-----------	---------------------------

PARKER AUTHORIZED SERVICE STATION

REPAIR TOOL ASSORTMENT J.

	<u>Tool</u>	<u>Net Price</u>
1.	Pliers - for fitting nib, feed in section. . . .	\$ 2.95
2.	Nib Pliers - for spacing and adjusting nibs. . . .	4.90
3.	1 Pair Section Pliers (protect jaws with rubber tubing) - for removing sections and shells from pen barrels.	4.00
4.	#17166 61 Cell Case Staking Pliers	3.25
5.	#12827 Universal Nipple Wrench	15.00
6.	#8674 Filler Unit Clamp - for removing and inserting all filler units except senior lock.	6.25
7.	#13174 Barrel and Pencil Point Drill - 1/32" with handle.80
8.	#11593 Regular Nib Grader - for gauging nibs to match fineness	3.50
9.	#11594 Extra Fine and Needle Nib Grader - for gauging nibs to match fineness	3.50
10.	#8573R1 "51" Nib Puller - for removing nib from front end of shell10
11.	Ten Spacing Steels - for medium nibs . . . @ .04	.40
12.	#993-R2 Nib Spacing Steel.50
13.	Rubber Tubing - for covering jaws of pliers - per foot45
14.	1 Piece Palm Grip - to be used as friction hand grip to hold pen barrel, tighten clip screws, etc.25
15.	Magnifying Glass - for inspecting nibs	1.70
16.	#9592R1 Disassembly Block and Rod.	2.25
17.	#8057 Arbor for "51" pen caps - for removing and fitting clips.	3.00
18.	#18028 Cap Liner Bushing Arbor75
19.	Alcohol Lamp - for heating down feeds, shells, etc.	1.50
20.	#13346 Pencil Clip Tool - for "21" pen	5.50
21.	#13373 Pen Assembly Tool - for "21" pen.	17.00

22.	#12039 Filler Unit Tester	\$ 2.25
23.	Rubber Bulbs for Filler Unit Tester and flushing 61 pens75 .75
24.	#15009 Writefine Cap Burnishing Tool - for "51" and "21"	2.25
25.	#17128 61 Cell Case Burnishing Tool	2.50
26.	#86758 Regular Carbide Tipped Lathe Cutting Tool .	5.50
27.	6 in. Buffing Wheel Pad (6-8 pads per wheel) per pad30
28.	8 in. Buffing Wheel Pad (6-8 pads per wheel) per pad45
29.	10 in. Buffing Wheel Pad (15 pads per wheel) per pad55
30.	Pumice (Bobbing Compound) 2# bar	1.00
31.	1 oz. Rouge Gold Polish - to be applied on cloth for polishing metal parts10
32.	PC-93 (formerly steel shine polish) 1½# bar	1.50
33.	1 Bottle Liquid Polish - 1 oz. - for polishing barrels and caps25
34.	Spec. #1128 Cement - 1 oz. - can be used on all pens25
35.	Spec. #720 Cement - 1 oz. - for use on "21", "51", and 61's only25
36.	Spec. #122 Cement - 1 oz. - for use on 61 sealing valve seat25
37.	1 pint carton Q.H.D.* - cleaning powder	1.00
38.	1 pint carton A-11** - conditioning powder50
39.	Skelly "B" - for thinning cements and removing glue on pen parts - 1 qt.50
	*Q.H.D. - Use one heaping tablespoon to a pint of water - water should be room temperature. This solution <u>must be made fresh daily.</u>	
	**A-11 - Mix one tablespoon to a gallon of water. Issue to repairmen in quantities of two ounces per day, as this solution should be replaced on the repair bench daily or more often if necessary to avoid contamination.	
40.	Gold Crayon - for filling in engraving75
41.	Silver Crayon - for filling in engraving50
42.	Ink Extractor (Electric and Controls)	145.00
43.	Ink Extractor Pen Holder	7.50

Envelopes

#3652 Repair Job Envelopes - per M \$ 9.00
 - per 100 1.00

Plain Cellophane Bags for finished repairs -
 per M. 3.00
 (Minimum Order - M)

Boxes - Chipboard

#800 6 3/8 x 1 3/8 x 3/4 ea. .06
 #801 7 1/4 x 2 1/2 x 1 5/8 ea. .06
 #802 7 1/4 x 3 3/4 x 1 1/2 ea. .07
 #803 7 3/4 x 5 1/4 x 2 3/4 ea. .09
 (Minimum Order - 30 Boxes)

Boxes - Corrigated

#804 8 1/4 x 6 1/2 x 3 ea. .05
 #805 7 3/4 x 6 1/2 x 5 3/4 ea. .06
 (Minimum Order - 30 Boxes)

Leads (Bulk Only)

1 3/8" x .036 Short Writefine (per gross)	@	<u>List</u> 1.60	5 gross minimum
2 3/4" x .036 Long " " "	@	1.00	" " "

Erasers and Ferrules (Bulk Only)

"51" CF Erasers (per gross)	@	<u>Net</u> 1.10	(per M)	@	<u>Net</u> 5.60	1 gross minimum
" " Ferrules " " "	@	3.50	" "	@	21.00	" " "
Short Erasers " " "	@	5.00	" "	@	30.00	" " "

ALL PRICES SUBJECT TO CHANGE WITHOUT NOTICE.

T H E P A R K E R P E N C O M P A N Y

J A N E S V I L L E W I S C O N S I N U . S . A .

Dear Parker Dealer:

We have been analyzing the repair work and find that many times you are sending repairs to Janesville rather than to the proper Parker owned service branch.

These service branches are organized on a factory base and can provide you with far more efficient service without sacrificing any skill in repair.

In the future would you please send any and all repairs to the Parker branch located nearest you as we are reducing our service facilities in the Janesville plant to make room for increased production.

The above information pertains to merchandise repair and exchanges only and does not affect parts handled. You will continue to send parts orders and exchanges to Janesville for handling and please do not include any pen repairs in these shipments.

The Parker service branches in the United States are located in the following places:

207 West 9th Street
Wilmington 1, Delaware

209 South 15th Street
Omaha 2, Nebraska

3728 Williamson Road, N. W.
Roanoke, Virginia

220 Book Building
Detroit 26, Michigan

1111 Citizens Building
Cleveland 14, Ohio

36 South State Street
Chicago 3, Illinois

134 Chestnut Street
Springfield 3, Massachusetts

33 West 60th Street
New York 23, New York

152 Walton Street, N. W.
Atlanta 3, Georgia.

278 Post Street
San Francisco 8, California

~~1812~~ North Industrial Boulevard
Dallas 7, Texas

Cordially,

THE PARKER PEN COMPANY

John B. Francis



Director of Service

JBF/ms

P A R K E R P E N



NEWS

May 1957

Volume IV

Number III

Published for Pen Service Stations
The Parker Pen Company, Janesville, Wis.

PEN LATHE

Many service stations have wanted a pen lathe and buffer that was not only practical, but inexpensive.

The attached picture illustrates a bench lathe that is sturdy and compact, at a price far below anything previously available.

We do not have these lathes in stock but will order them after we have received your orders. We will need 30 to 60 days to have them built.

WE WILL SUPPLY THE LATHE WITHOUT MOTOR. We recommend a 1/6 h.p. motor, about 1100 r.p.m.

The price of the lathe (less motor) is \$60.00 net f.o.b. Janesville.

All orders must be in here by June 7.

Carbide tipped cutting tools are available @ \$2.30 - #86758

8" Buffing Wheels (10 pads to a set) @ \$.45

Pumice (about 1 lb.) @ \$1.00

Steel Shine (about 1 lb.) @ \$1.50

The Parker Pen Company, Janesville, Wis., U. S. A.

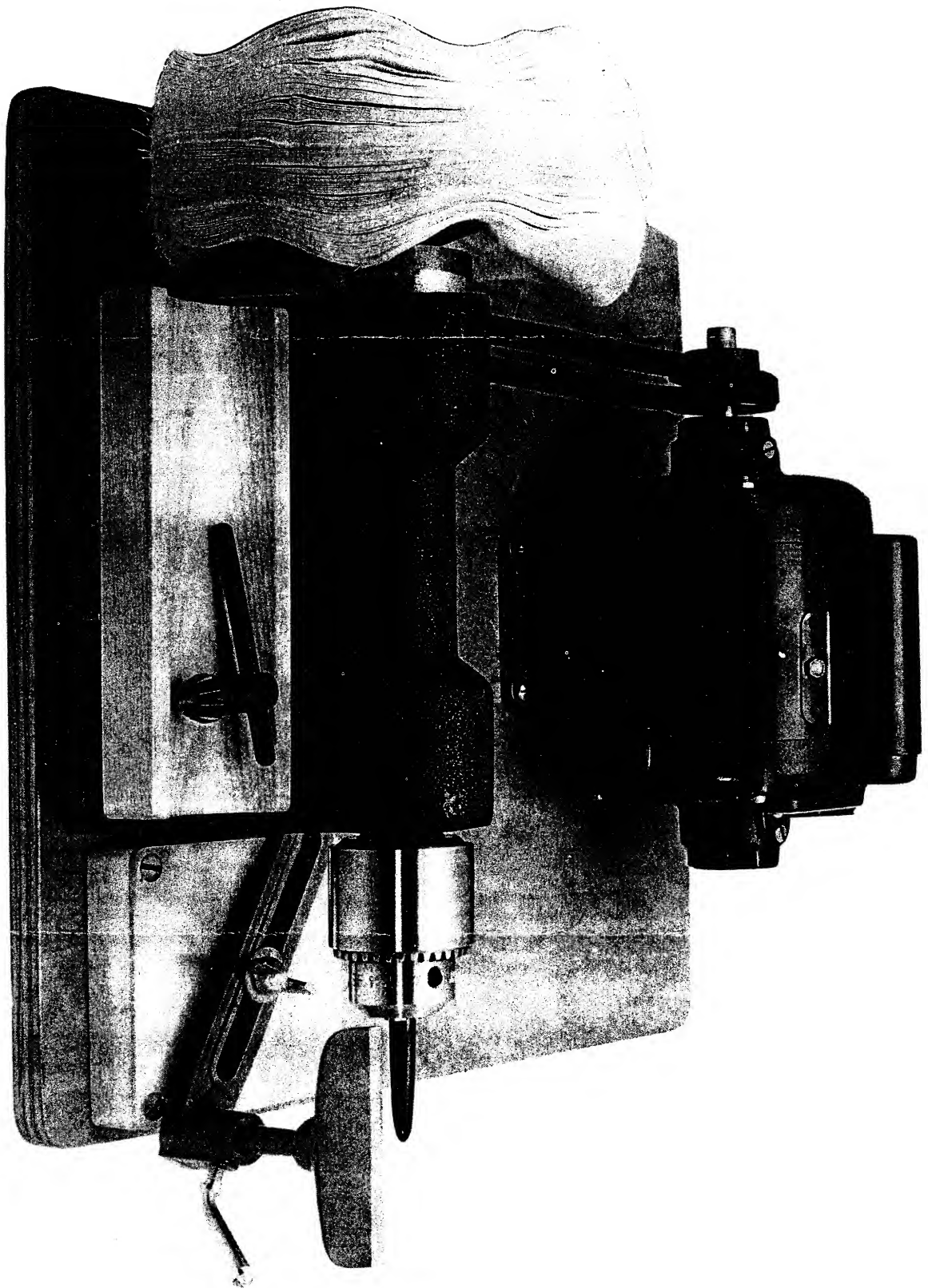

All Purpose Pen Turning and Buffing Lathe No. 17874

(Order motor, pulley and belt separately)

November 1961

Below are listed the part numbers, part description, list price (order and exchange) for the Parker "51" Cartridge Pen newly released.

As we are in the process of constructing a new Parker Repair Parts Price List Book, new pages covering this pen will not be sent to you at this time. Therefore, please insert this sheet in your present book for reference when ordering parts.

PART NUMBER	DESCRIPTION	LIST PRICE	
		Order (Missing)	Exchange (Damaged)
586-180-1	Cap with Clip	\$5.50	\$4.10
586-002-1	Cap less Clip	4.75	3.35
586-013	Clip	.75	.75
295-165	Nib	4.50	1.50
808-151	Shell	.60	.60
808-149	Collector	.50	.50
808-365	Piercing Tube	.10	.10
808-006	Feed	.26	.26
808-004	Barrel	1.50	.80
808-096	Barrel Band	.10	.10
808-052	Connector	.15	.15
51-811A	Clipscrew	.10	.10
74-097-1	Bushing	.10	.10
586-011-1	Inner Cap	.10	.10
735-152	Clutch	.10	.10

Colors: Black, Navy Grey, Burgundy, Teal Blue

Price changes have been made on the following nibs:

653-165	14K Gold - 61	4.50	1.50
295-165	14K Gold - "51"	4.50	1.50
626-165	Octanium - 41, "51" Standard, Super "21", Parker Desk Pen & Debutante	1.35	1.35
607-165	Octanium - "21" Model 607	1.35	1.35
615-286	Octanium - "21" Model 615 - Nib-Feed-Shell Assembly	1.35	1.35

Thank you for this opportunity of saying hello to you and introducing myself, and will each of you introduce yourself to me as the situation may arise.

John B. Francis

John B. Francis

General Service Manager

JBF/lh

THE PARKER PEN COMPANY --

30 Rockefeller Plaza
New York 20, New York

33 West 60th Street
New York 23, New York

36 South State Street
Chicago 3, Illinois

278 Post Street
San Francisco 8, California

PARKER PEN SERVICE, INC. --

101 Marietta St. Bldg.
Atlanta 3, Georgia

1113 Citizens Bldg.
Cleveland 14, Ohio

1812 N. Industrial Blvd.
Dallas 7, Texas

220 Book Building
Detroit 26, Michigan

306 South 24th Street
Omaha 2, Nebraska

3728 Williamson Road, N.W.
Roanoke, Virginia

134 Chestnut Street
Springfield 3, Massachusetts

207 W. Ninth Street
Wilmington 1, Delaware

200
1.25
100
425